

SERVICE MANUAL

ADCOM[®]

POWER AMPLIFIER

GFA-535 II

TABLE OF CONTENTS

Introduction	1
Test Procedures	2
Chassis Layout.....	3
Wiring Diagram	4
Service Parts List	5
Performance Data	9
Specifications	11
Filter Capacitor PCB	13
AC Input PCB	13
Amplifier PCBs	14
Schematic Diagram	15

ADCOM[®]

TECHNICAL SERVICE DEPARTMENT

11 ELKINS ROAD

EAST BRUNSWICK, NJ 08816 U.S.A.

TELEPHONE (908) 390-1130

FAX (908) 390-9152

INTRODUCTION

This service manual is intended to assist trained and qualified technical personnel in verifying the performance of, adjusting, and repairing the ADCOM GFA-535II power amplifier. The procedures described here are not intended for persons unfamiliar with the appropriate safety and test procedures.

WARNING

THERE ARE POTENTIALLY LETHAL VOLTAGES WITHIN THE GFA-535II AMPLIFIER WHICH WILL BE ACCESSIBLE ONCE ITS TOP COVER IS REMOVED. **DO NOT ATTEMPT FAMILIARIZATION, INSPECTION OR ANY PROCEDURE WHATSOEVER UNLESS YOU HAVE DISCONNECTED THE GFA-535II FROM THE WALL AC OUTLET OR OTHER SOURCE OF AC POWER AND THE POWER-SUPPLY CAPACITORS ARE COMPLETELY DISCHARGED.** PLEASE TAKE NOTE THAT THE POWER-SUPPLY CAPACITORS TAKE AS LONG AS **5 MINUTES** TO DISCHARGE. THESE INSTRUCTIONS ARE PROVIDED FOR USE ONLY BY COMPETENT TECHNICAL PERSONNEL. **DO NOT UNDERTAKE ANY SERVICE PROCEDURES IN THE GFA-535II UNLESS YOU ARE TECHNICALLY QUALIFIED TO DO SO.**

CIRCUIT DESCRIPTION

The ADCOM GFA-535II is a stereo power amplifier rated at less than 0.04% THD from 20Hz to 20kHz with 60 watts into 8 ohms and 100 watts into 4 ohms. The output stage is capable of greater than 25 amps into low impedance loads. The amplifier employs a discrete differential Class-A front-end followed by a Class-A voltage-gain stage which amplify the input signal to the voltage required at the output of the amplifier. This high-voltage signal drives the high-current triple-Darlington-follower output stage which amplifies the current by a factor of about 50,000.

Referring to the accompanying schematic, describing the Left Channel only, the input signal passes through network C601, C603, R603, and R607 which provide a 3dB bandwidth of 1.7Hz to 500kHz to the input of the amplifier. C601 is an extremely high quality capacitor and serves to protect the amplifier and the speakers connected to it from DC faults at the output of the preamplifier. **WE DO NOT RECOMMEND THAT C601 BE SHORTED OUT.** Q601 and Q603 form the differential input stage.

Open-loop gain is defined by R615 and the bias current through Q601 and Q603. The small-signal gain is approximately $825/(2 \times 25) = 16$. The next voltage gain stage consists of Q613 with Q615 as a current-source load. DC bias is set by R635, D605 and D607. Its open loop-gain is defined by R639 and R641, with R651, R653, C609, C613, and C615 providing high-frequency compensation.

Feedback is provided from the output to the base of Q603 by the network R611, R613 and C607. C607 provides a high-frequency roll-off above 150kHz, improving stability by taking high-frequency feedback before the triple Darlington.

The input stage is biased by R619, R623, R625, R627, R629, R631, R633, R635, Q605, Q609, Q615, D601, D603, D605, D607, D609 and the overtemperature LED, D004. Q609 is turned on when the B+ supply is on. A current of about 4mA flows through the thermal breaker on the heatsink and into D605 and D607. If the heatsink overheats, the breaker opens and the current flows through D609 and the THERMAL PROTECTION LED instead. When the breaker carries the current, D605 and D607 are biased at 1.4V. This creates about 0.7V across R619; Q605 then sources about 2mA to Q601 and Q603, the differential input stage. If the negative supply fails or its fuse opens, Q605 saturates, Q601 turns off, turning off Q613, D613 turns on and Q615 saturates. This holds the input to the Triple Darlington to near ground. If the positive supply fails or its fuse opens, Q609 turns off and the bias circuitry is disabled.

Any DC imbalance in the amplifier is corrected by R687, R689, C623, C625, and IC601. Any DC error at the amplifier output is servoed back through IC601 to adjust the DC current through the input transistors. DC-bias is nominally 1.0mA through Q601 and Q603. IC601 provides the DC-bias current to Q601 and can swing from ground to +10V to bring the amplifier into balance.

The bias network of VR601, R643, R645, and Q617 form a temperature- compensated DC-bias voltage to the input of the triple-Darlington-follower output stage. Mid- and high-frequency bypassing is provided by C611.

R693 and C617 provide a load for the amplifier at high frequencies, stabilizing the amplifier under varying load conditions. D611 and D613 provide a high-current return to the power supply for backlash current from the load.

The output stage consists of two sets of 2 parallel transistors operated as emitter followers, driven by another pair of emitter followers. This configuration minimizes distortion caused by varying load impedances. The output transistors have 0.22-ohm ballast resistors to ensure current sharing and bias stability.

TEST PROCEDURES

All tests are performed with a 120V, low-distortion (less than 2%), AC-power source, 8-ohm resistive load, (except slew rate), and a signal source of not more than 600 ohms.

Tests are performed after warming up the amplifier at 20 watts into an 8-ohm load for at least 10 minutes.

All grounds during testing are referred to the ground of the black output terminal, **EXCEPT FOR RCA INPUT-JACK GROUNDS AND ANY SIGNAL-GENERATOR GROUND. DO NOT CONNECT RCA INPUT-JACK GROUNDS TO BLACK OUTPUT-TERMINAL BINDING POSTS, OR DAMAGE TO THE GROUNDING SYSTEM OF THE AMPLIFIER MAY RESULT.**

80kHz low-pass filter is employed during THD distortion measurements.

Signal-to-noise measurements are "A" weighted.

Damping factor is measured by comparing the 20-watt-output voltage with and without an 8-ohm load.

Slew rate is measured with an inductive load, and is derived with a dual-time-based oscilloscope reading the slope of a full-power (70V peak-to-peak) 5kHz square wave. To avoid damaging output networks R693/C617 AND R694/ C618 **DO NOT OPERATE THE AMPLIFIER AT FULL-POWER, SINE-WAVE ABOVE 22kHz OR FULL-POWER (70V PEAK-TO-PEAK) SQUARE WAVE ABOVE 5kHz.**

IMPORTANT

BEFORE PROCEEDING WITH ADJUSTMENTS, MAKE SURE AMPLIFIER IS AT ROOM TEMPERATURE.

BIAS ALIGNMENT

1. With set-up as per the first paragraph of TEST PROCEDURES and with **NO SIGNAL IN**, set bias controls (VR601 and VR602) to midpoint.
2. Connect a millivolt meter across TP1 and TP2.
3. Turn amplifier on and allow a 3 to 5 minute settling period.
4. Adjust **BIAS** control VR601 to obtain either a + or - 7mV ($\pm 1\text{mV}$) indication on the millivolt meter.
5. Connect a millivolt meter across TP3 and TP4.
6. Adjust **BIAS** control VR602 to obtain either a + or - 7mV ($\pm 1\text{mV}$) indication on the millivolt meter.
7. To check for proper bias setting, remove millivolt meter and apply input signal to obtain 20 watts into 8 ohms for 10 minutes with cover on.
8. Remove input signal and connect the millivolt meter as in Step 2 and Step 5. Let amplifier idle until bias stabilizes and readjust to 7mV ($\pm 1\text{mV}$).

GFA-535II CHASSIS LAYOUT

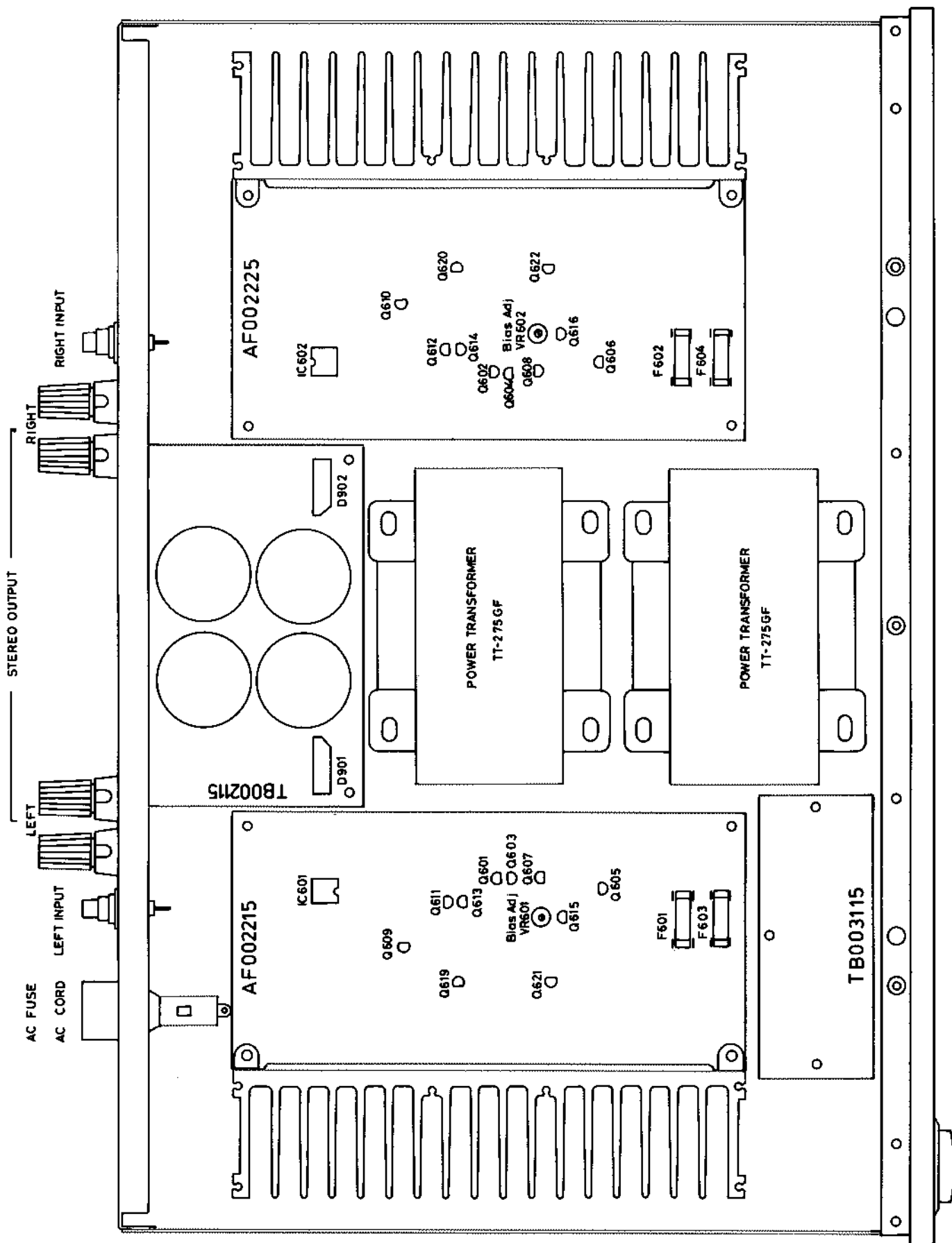

GFA-535II WIRING DIAGRAM

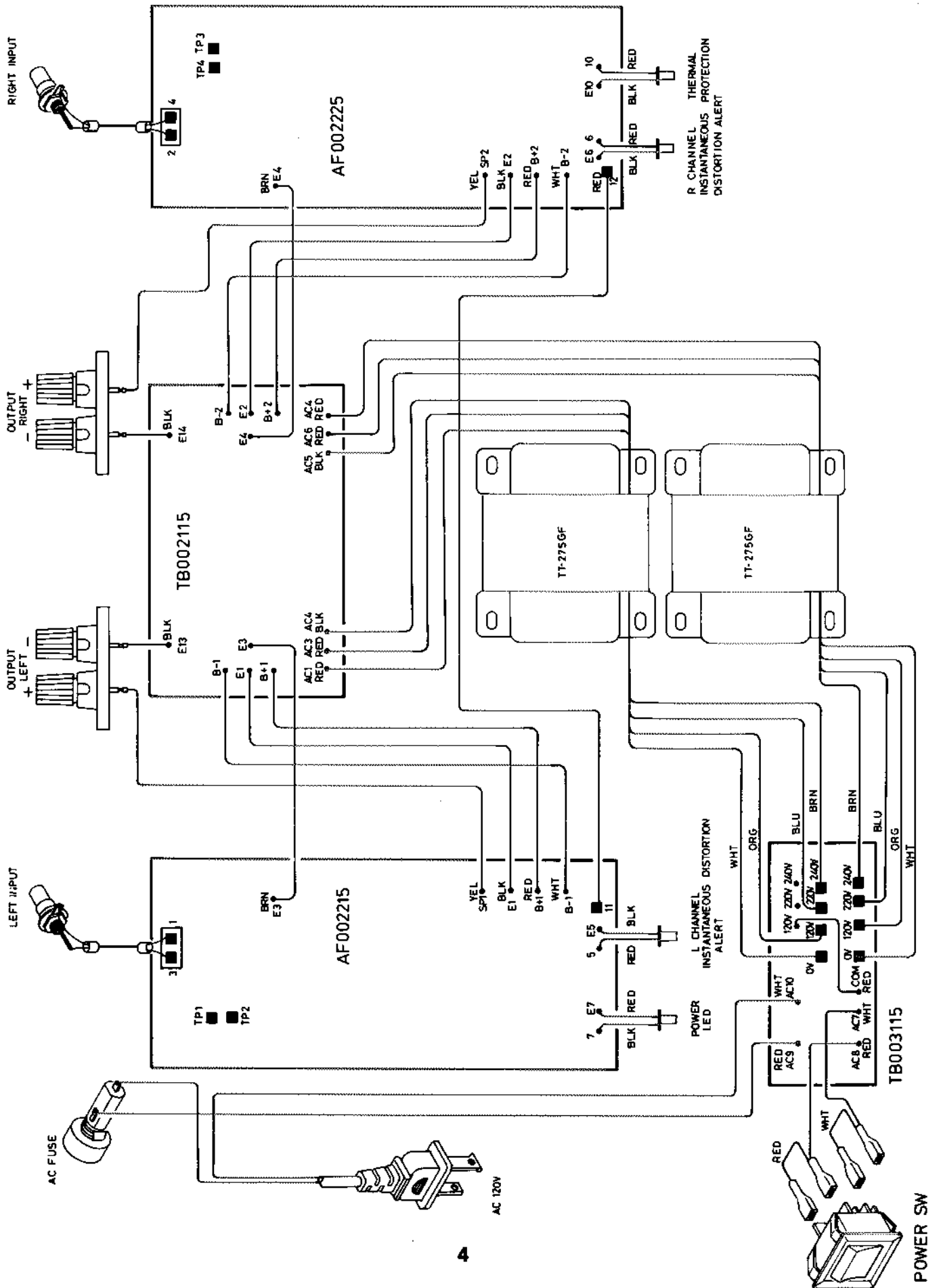

ADCOM GFA-535II SERVICE PARTS LIST

SCHEMATIC LOCATION	PART NUMBER	DESCRIPTION
AF002215 PCB ASSEMBLY		
R601	RM81004613	METAL-FILM MK2 001MFECZ *
R603	RM81001612	METAL-FILM MK2 001KFECZ *
R605	RM81504610	METAL-FILM MK2 01M5FECZ *
R607	RM81003610	METAL-FILM MK2 100KFECZ *
R609	RM81000619	METAL-FILM MK2 100RFECZ *
R611	RM81001612	METAL-FILM MK2 001KFECZ *
R613	RM82212618	METAL-FILM MK2 22K1FECZ *
R615	RM88250617	METAL-FILM MK2 825RFECZ *
R617	RM83650617	METAL-FILM MK2 365RFECZ *
R619	RM83010616	METAL-FILM MK2 301RFECZ *
R621	RM81821615	METAL-FILM MK2 1K82FECZ *
R623	RM84752616	METAL-FILM MK2 47K5FECZ *
R625	RM82212618	METAL-FILM MK2 22K1FECZ *
R627	RM81330619	METAL-FILM MK2 133RFECZ *
R629,631	RM81002616	METAL-FILM MK2 010KFECZ *
R633	RM84750619	METAL-FILM MK2 475RFECZ *
R635	RM81330619	METAL-FILM MK2 133RFECZ *
R637	RM81001612	METAL-FILM MK2 001KFECZ *
R639,641	RM83329610	METAL-FILM MK2 33R2FECZ *
R643	RM81821615	METAL-FILM MK2 1K82FECZ *
R645	RM86810619	METAL-FILM MK2 681RFECZ *
R647,649	RM81000619	METAL-FILM MK2 100RFECZ *
R651,653	RM84759611	METAL-FILM MK2 47R5FECZ *
R655,657	RM81001612	METAL-FILM MK2 001KFECZ *
R659	RM84750619	METAL-FILM MK2 475RFECZ *
R661	RM83329610	METAL-FILM MK2 33R2FECZ *
R663,665	RM81009611	METAL-FILM MK2 010RFECZ *
R667,669	RS20228230	CEMENTED WIRE-WOUND MPC70-0.22F
R671,673	RM81009611	METAL-FILM MK2 010RFECZ *
R675,677	RS20228230	CEMENTED WIRE-WOUND MPC70-0.22F
R687,689	RM84754613	METAL-FILM MK2 4M75FECZ *
R691	RM83322614	METAL-FILM MK2 33K2FECZ *
R693	RM14708225	METAL-OXIDE RSS2X-4.7F
R695	RM95601126	METAL-OXIDE 1W 5.6K
C601	CP61007330	POLYCARBONATE, 1uF/100V MKC62-100V105 OR ELECTRONIC CONCEPTS 5MC22B105K
C603	CS33311321	POLYSTYRENE, 330pF/125V SRA331J125
C605	CP61007432	POLYESTER, 1uF/100V MKT22-100V105
C607	CS34712323	POLYSTYRENE, 47pF/125V SRA470J125
C609	CS32212323	POLYSTYRENE, 22pF/125V SRA220J125
C611	CE74713502	ELECTROLYTIC, 4.7uF/50V ECEA1HFS4R7
C613,615	CS31011322	POLYSTYRENE, 100pF/125V SRA101J125
C617	CP61008321	POLYESTER, 0.1uF/100V MKT18-100V104
C619,621	CE74706340	ELECTROLYTIC, 47uF/100V ECEA2AGE470
C623,625,627	CP61008321	POLYESTER, 0.1uF/100V MKT18-100V104
C629	CE74713502	ELECTROLYTIC, 4.7uF/50V ECEA1HES4R7
C631	CM01009427	MYLAR, 0.01uF/50V P50V103J
IC601	IC00002387	ADCOM 3A
D601,603, 605,607,609	DD10000100	IN4148TF-B
D611,613	DD10000068	1N4003
D615	DD20000016	RD12EBT1
Q601,603,605	TR30000212	2SC2362KAA-FG
Q607,609	TR10000023	2SA1016KAA-FG
Q611	TR10000126	2SA608KAA-FG
Q613	TR10000023	2SA1016KAA-FG

Q615	TR30000212	2SC2362KAA-FG
Q617	TR40000112	2SD1684-RS
Q619	TR30000558	2SC3478T-LK
Q621	TR10000308	2SA1376T-LK
Q623	TR30000560	2SC4381-OY
Q625	TR10000291	2SA1667-OY
Q627	TR30000534	2SC3856-OPY
Q629	TR10000278	2SA1492-OPY
Q631	TR30000534	2SC3856-OPY
Q633	TR10000278	2SA1492-OPY
F601,603 §	△ AGC-4/250V	BUSSMAN
	△ 3AG312004/250V	LITTELFUSE
	△ 3AG 4A/250V	BEL
S601	△ SH60000148	THERMOSTAT, UP62 85°C C-4270A01
VR601	RV40000022	VARIABLE, SF689A-2.2K

AF002225 PCB ASSEMBLY

R602	RM81004613	METAL-FILM MK2 001MFECZ *
R604	RM81001612	METAL-FILM MK2 001KFECZ *
R606	RM81504610	METAL-FILM MK2 01M5FECZ *
R608	RM81003610	METAL-FILM MK2 100KFECZ *
R610	RM81000619	METAL-FILM MK2 100RFECZ *
R612	RM81001612	METAL-FILM MK2 001KFECZ *
R614	RM82212618	METAL-FILM MK2 22K1FECZ *
R616	RM88250617	METAL-FILM MK2 825RFECZ *
R618	RM83650617	METAL-FILM MK2 365RFECZ *
R620	RM83010616	METAL-FILM MK2 301RFECZ *
R622	RM81821615	METAL-FILM MK2 1K82FECZ *
R624	RM84752616	METAL-FILM MK2 47K5FECZ *
R626	RM82212618	METAL-FILM MK2 22K1FECZ *
R628	RM81330619	METAL-FILM MK2 133RFECZ *
R630,632	RM81002616	METAL-FILM MK2 010KFECZ *
R634	RM84750619	METAL-FILM MK2 475RFECZ *
R636	RM81330619	METAL-FILM MK2 133RFECZ *
R638	RM81001612	METAL-FILM MK2 001KFECZ *
R640,642	RM83329610	METAL-FILM MK2 33R2FECZ *
R644	RM81821615	METAL-FILM MK2 1K82FECZ *
R646	RM86810619	METAL-FILM MK2 681RFECZ *
R648,650	RM81000619	METAL-FILM MK2 100RFECZ *
R652,654	RM84759611	METAL-FILM MK2 47R5FECZ *
R656,658	RM81001612	METAL-FILM MK2 001KFECZ *
R660	RM84750619	METAL-FILM MK2 475RFECZ *
R662	RM83329610	METAL-FILM MK2 33R2FECZ *
R664,666	RM81009611	METAL-FILM MK2 010RFECZ *
R668,670	RS20228230	CEMENTED WIRE-WOUND MPC70-0.22F
R672,674	RM81009611	METAL-FILM MK2 010RFECZ *
R676,678	RS20228230	CEMENTED WIRE-WOUND MPC70-0.22F
R688,690	RM84754613	METAL-FILM MK2 4M75FECZ *
R692	RM83322614	METAL-FILM MK2 33K2FECZ *
R694	RM14708225	METAL-OXIDE RSS2X-4.7F
C602	CP61007330	POLYCARBONATE, 1uF/100V MKC62-100V105
		OR ELECTRONIC CONCEPTS 5MC22B105K
C604	CS33311321	POLYSTYRENE, 330pF/125V SRA331J125
C606	CP61007432	POLYESTER, 1uF/100V MKT22-100V105
C608	CS34712323	POLYSTYRENE, 47pF/125V SRA470J125
C610	CS32212323	POLYSTYRENE, 22pF/125V SRA220J125
C612	CE74713502	ELECTROLYTIC, 4.7uF/50V ECEA1HFS4R7
C614,616	CS31011322	POLYSTYRENE, 100pF/125V SRA101J125
C618	CP61008321	POLYESTER, 0.1uF/100V MKT18-100V104
C620,622	CE74706340	ELECTROLYTIC, 47uF/100V ECEA2AGE470
C624,626,628	CP61008321	POLYESTER, 0.1uF/100V MKT18-100V104
C630	CE74713502	ELECTROLYTIC, 4.7uF/50V ECEA1HES4R7
C632	CM01009427	MYLAR, 0.01uF/50V P50V103J

IC602	IC00002387
D602,604,	DD10000100
606,608,610	
D612,614	DD10000068
D616	DD20000016
Q602,604,606	TR30000212
Q608,610	TR10000023
Q612	TR10000126
Q614	TR10000023
Q616	TR30000212
Q618	TR40000112
Q620	TR30000558
Q622	TR10000308
Q624	TR30000560
Q626	TR10000291
Q628	TR30000534
Q630	TR10000278
Q632	TR30000534
Q634	TR10000278
F602,604 §	△ AGC-4/250V
	△ 3AG312004/250V
	△ 3AG 4A/250V
S602	△ SH60000148
VR602	RV40000022

ADCOM 3A
 IN4148TF-B
 1N4003
 RD12EBT1
 2SC2362KAA-FG
 2SA1016KAA-FG
 2SA608KAA-FG
 2SA1016KAA-FG
 2SC2362KAA-FG
 2SD1684-RS
 2SC3478T-LK
 2SA1376T-LK
 2SC4381-OY
 2SA1667-OY
 2SC3856-OPY
 2SA1492-OPY
 2SC3856-OPY
 2SA1492-OPY
 BUSSMAN
 LITTELFUSE
 BEL
 THERMOSTAT, UP62 85°C C-4270A01
 VARIABLE, SF689A-2.2K

TB002115 PCB ASSEMBLY

D901,902	△ DD10000020
R901,902,	RM95601928
903,904	
C901,902,	CE66804642
903,904	
C905,906,	CP62208330
907,908	

BRIDGE RECTIFIER PBL403
 METAL-FILM 1/2W 5.6KF
 ELECTROLYTIC 63LAP6800M
 POLYESTER, 0.22uF/100V MKT18-100V224

TB003115 PCB ASSEMBLY

C001	△ CK00000035
D001	△ DD30000104
D001	△ DD30000116

SPARK KILLER DE7150F472M
 METAL-OXIDE VARISTOR (120V) TNR9G221K
 METAL-OXIDE VARISTOR (220V/240V)
 TNR9G391K

CHASSIS MOUNTED COMPONENTS

D002	DD40000757
D003, D005	DD40000745
D004	DD40000757
T001, T002	△ PT27507106
S001	△ SH40000180
S001	△ SH40000192
F001 (120V) §	△ AGC-5/250V
	△ 3AG312005/250V
	△ 3AG 5A/125V
F001 (220V/240V) §	△ AGC-2.5A/250V
	△ 3AG31202.5/250V
	△ 3AG 2.5A/250
	△ CD00000220
	△ SC00000120
	VCRB2BPA
	AA80001497
	AA80001503
	AU00001160
	JP01000061
	FT00000035

LED RED, POWER ON, LTL2201A
 LED YELLOW, INSTANTANEOUS DISTORTION
 ALERT, LTL2251A
 LED RED, THERMAL PROTECTION, LTL2201A
 POWER TRANSFORMER TT-275GF
 POWER SWITCH, BLACK, RGSCC711-R-B-B-O
 POWER SWITCH, WHITE, RGSCC711-R-W-W-O
 BUSSMAN
 LITTELFUSE
 BEL
 BUSSMAN
 LITTELFUSE
 BEL
 AC POWER CORD 4TR-670#5 UL/CSA
 AC-CORD STRAIN RELIEF SR5KN-4
 SPEAKER TERMINALS, ONE PER CHANNEL
 FRONT PANEL, BLACK 2TQA-1#1 TFP-593
 FRONT PANEL, WHITE 2TQA-1#2 TFP-593
 TOP COVER 3TQA-5
 RCA JACKS, VTW-J5MI
 PLASTIC FOOT 4TR-1257 20x8

PACKING MATERIALS

PL00000654
GFA-535II

INNER PACKING 2 PIECES 2TR-2222A TZ-156
PACKING CARTON, WHITE

* ROEDERSTEIN 1/4W 1%, ONLY, TO PRESERVE LOW NOISE CHARACTERISTICS

§ The fuses listed, and their time-current blowing points, have been carefully selected and thoroughly tested to deliver optimal performance while still accomplishing their protective functions. Replace these fuses, individually, only with the specific types listed. **DO NOT USE ANY SUBSTITUTE FUSES WITH DIFFERENT RATINGS, TIME-CURRENT CURVES OR VALUES.** Failure to observe this precaution may cause serious damage to the amplifier circuits, **MAY CREATE A FIRE HAZARD, AND MAY VOID THE WARRANTY**

△ Because of fire, shock and/or other hazards, parts identified by and listed with this sign **MUST** be replaced with the **IDENTICAL FACTORY PART** listed in the **SERVICE PARTS LIST**. No substitutions with other "equivalent" parts can be made.

GFA-535II TYPICAL PERFORMANCE DATA

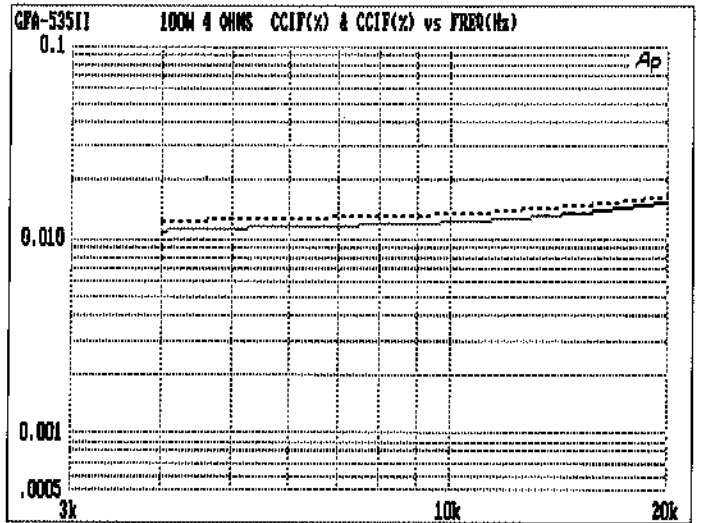
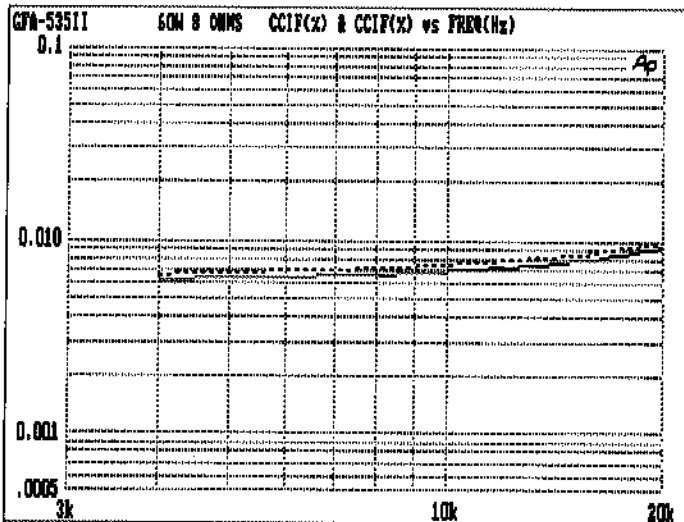
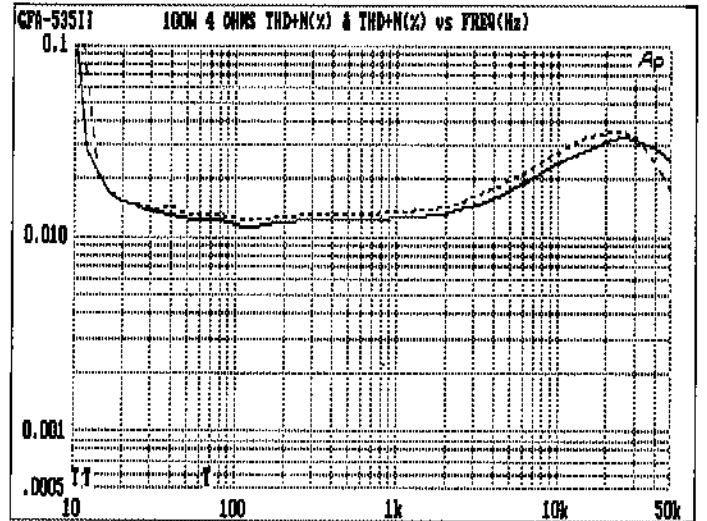
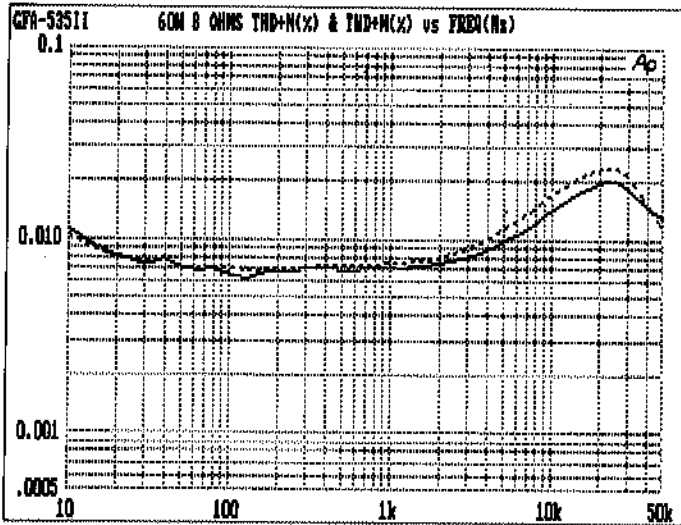
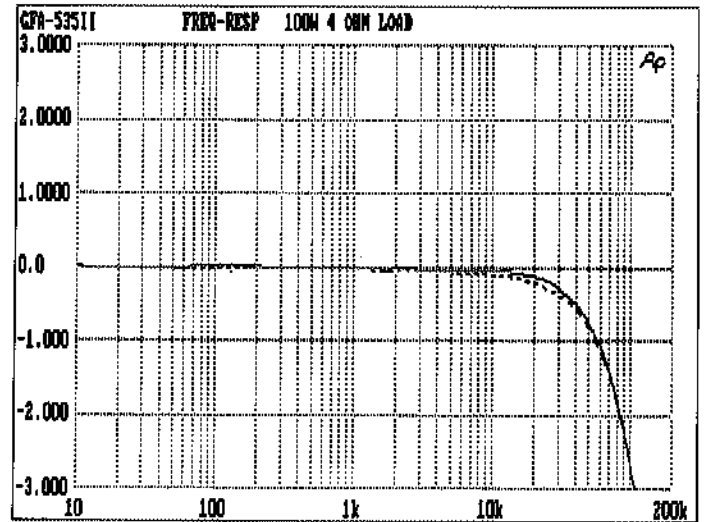
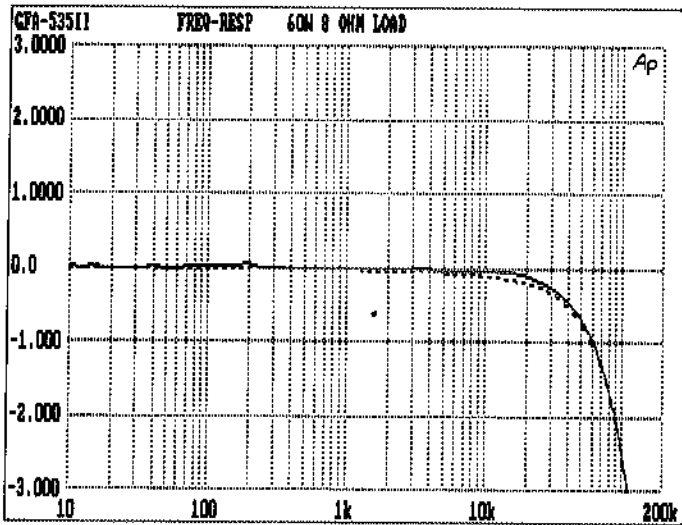

GFA-535II TYPICAL PERFORMANCE DATA

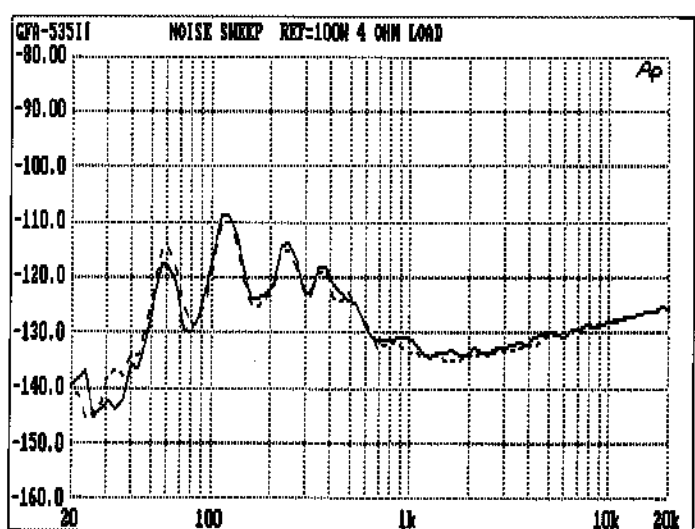
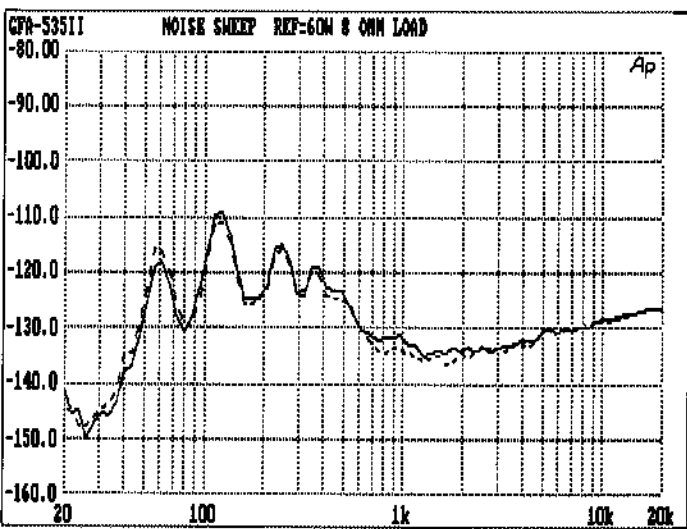
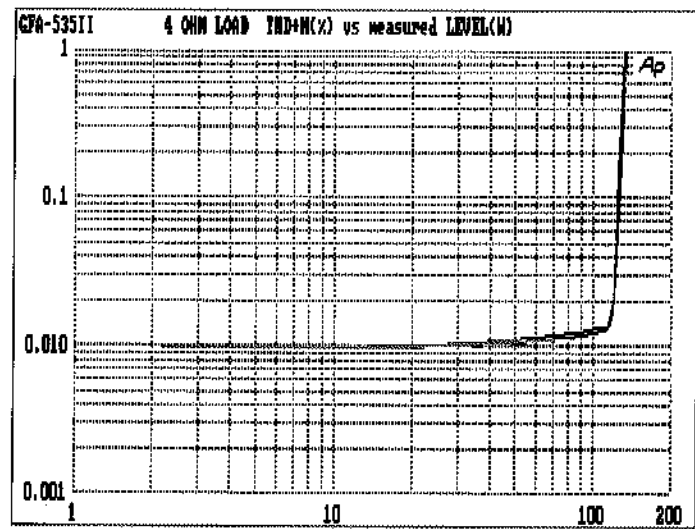
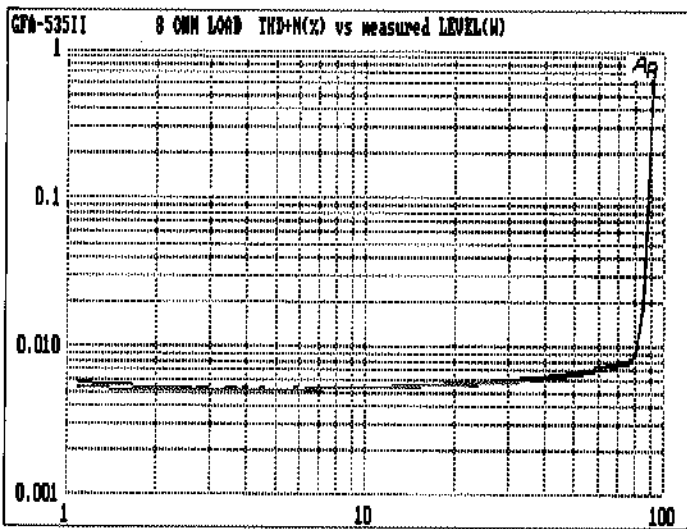
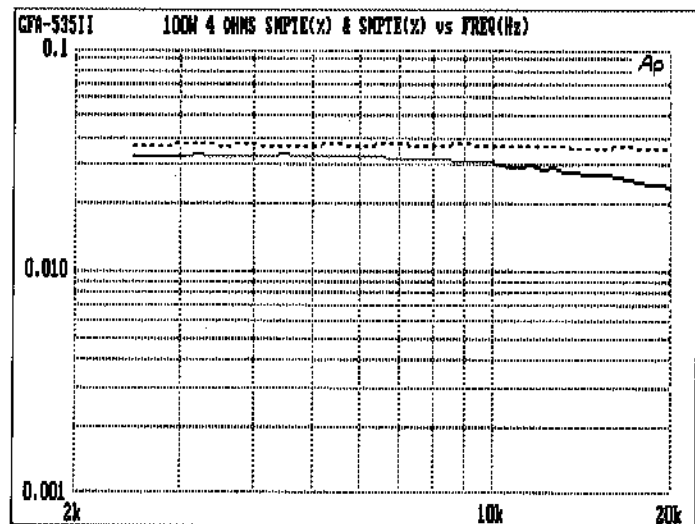
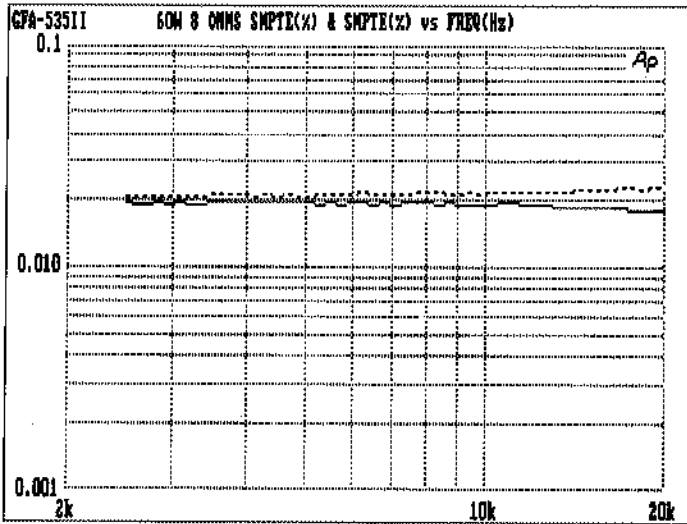

GFA-535II SPECIFICATIONS

Power Rating (To FTC Requirements)

60 watts continuous average power into 8 ohms at any frequency between 20Hz and 20kHz with both channels driven at less than 0.04% THD.

100 watts continuous average power into 4 ohms at any frequency between 20Hz and 20kHz with both channels driven at less than 0.04% THD.

IM Distortion (SMPTE)

1 watt to 60 watts into 8 ohms $\leq 0.05\%$
 1 watt to 100 watts into 4 ohms $\leq 0.05\%$

IM Distortion (CCIF, Any Combination from 4kHz to 20kHz)

60 watts into 8 ohms $\leq 0.02\%$
 100 watts into 4 ohms $\leq 0.02\%$

THD + Noise at 60 Watts into 8 Ohms

20Hz 0.01%
 1kHz 0.008%
 10kHz 0.015%
 20kHz 0.02%

THD + Noise at 100 Watts into 4 Ohms

20Hz 0.025%
 1kHz 0.015%
 10kHz 0.025%
 20kHz 0.03%

Frequency Response @ 1 Watt into 8 Ohms

10Hz to 20kHz +0, -0.25dB

Power Bandwidth (-3dB) 1.7Hz to 100kHz

Dynamic Headroom into 4 Ohms 3dB

Signal-to-Noise Ratio, "A" Weighted

60 Watts into 8 ohms $\geq 110\text{dB}$

Gain 27dB

Input Impedance 100,000 ohms

Input Sensitivity

60 watts into 8 ohms 0.97V rms
 1 watt into 8 ohms 130mV rms

Damping Factor

20Hz to 20kHz ≥ 180

Rise Time

5kHz, 70V peak-to-peak square wave, 20% to 80% 2.2us

Semiconductor Complement 34 transistors, 2 zener diodes,
 14 diodes, 2 ICs, 2 diode bridges

Power Consumption (Continuous, Both Channels Driven)

Quiescent	55VA
Maximum	600VA
60 watts into 8 ohms	240VA
100 watts into 4 ohms	410VA

GENERAL

Power (available in 220V or 240V on special order)	120VAC/50-60Hz
Chassis Dimensions	3"(76mm) x 17"(432mm) x 11-1/4"(286mm)
Maximum Dimensions	3-3/8"(86mm) x 17"(432mm) x 12-1/2"(317mm)
Weight	19.5 lbs.(8.9kg)
Weight,Packed	23 lbs.(10.5kg)

SPECIFICATIONS SUBJECT TO CHANGE WITHOUT PRIOR NOTICE



11 Elkins Road
East Brunswick, NJ 08816 U.S.A.
Telephone (908) 390-1130
Fax (908) 390-9152

FILTER CAPACITOR/RECTIFIER PCB ASSEMBLY

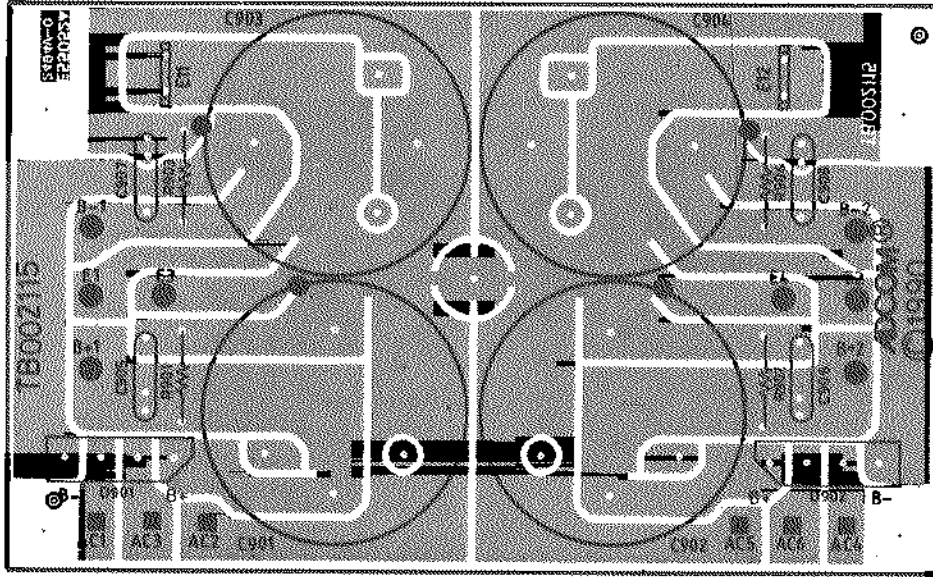

AC INPUT PCB

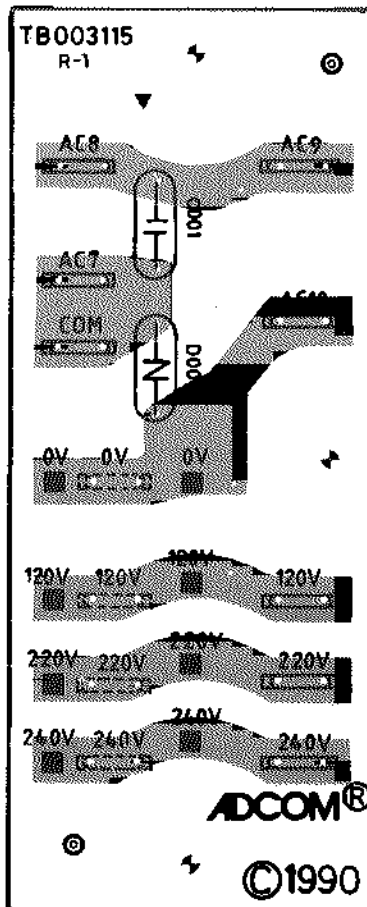

RIGHT AMPLIFIER PCB

LEFT AMPLIFIER PCB

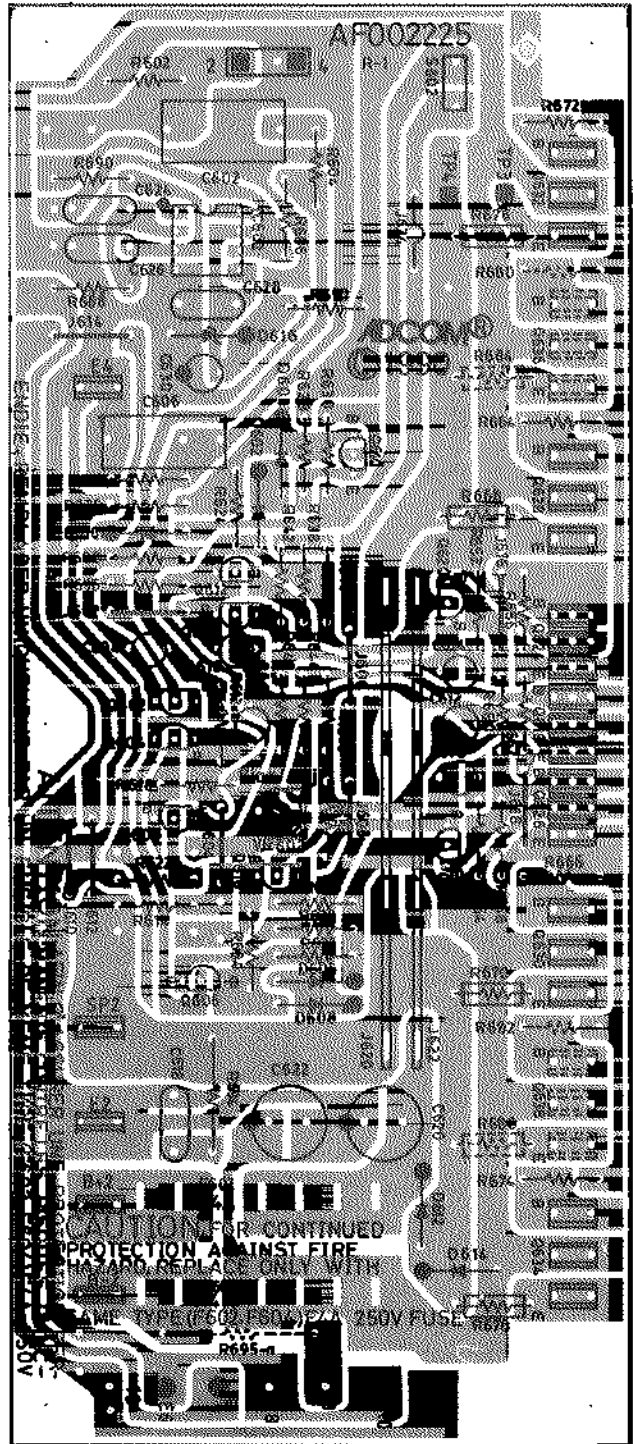
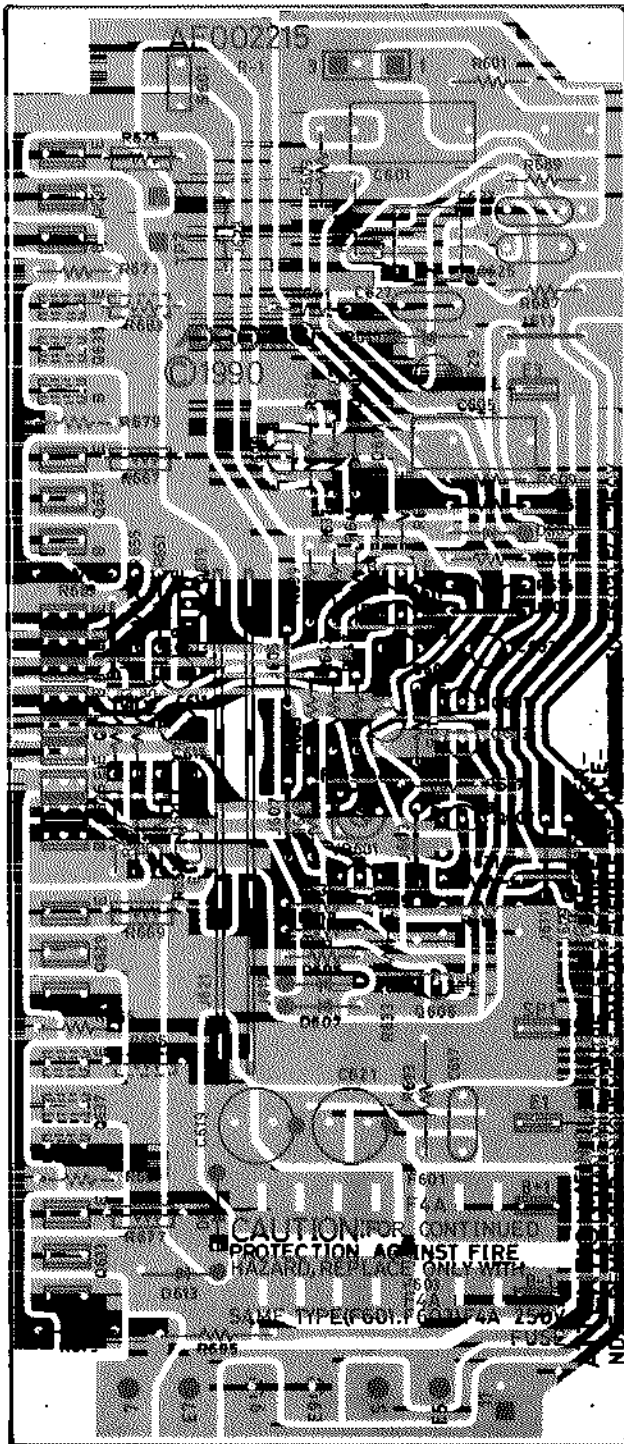

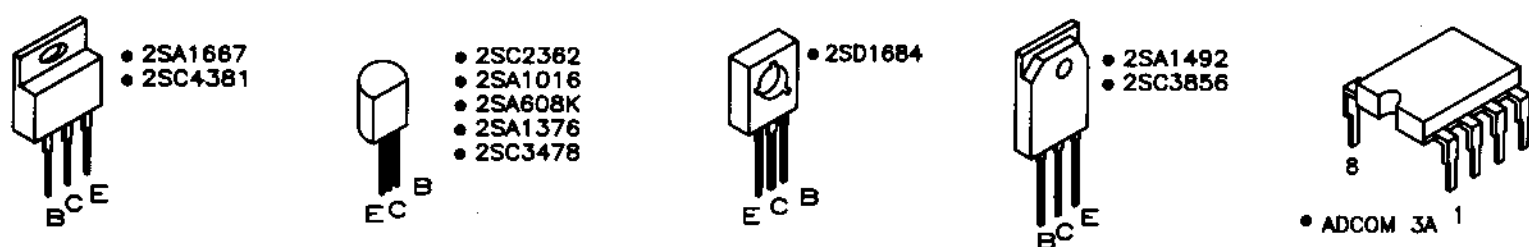
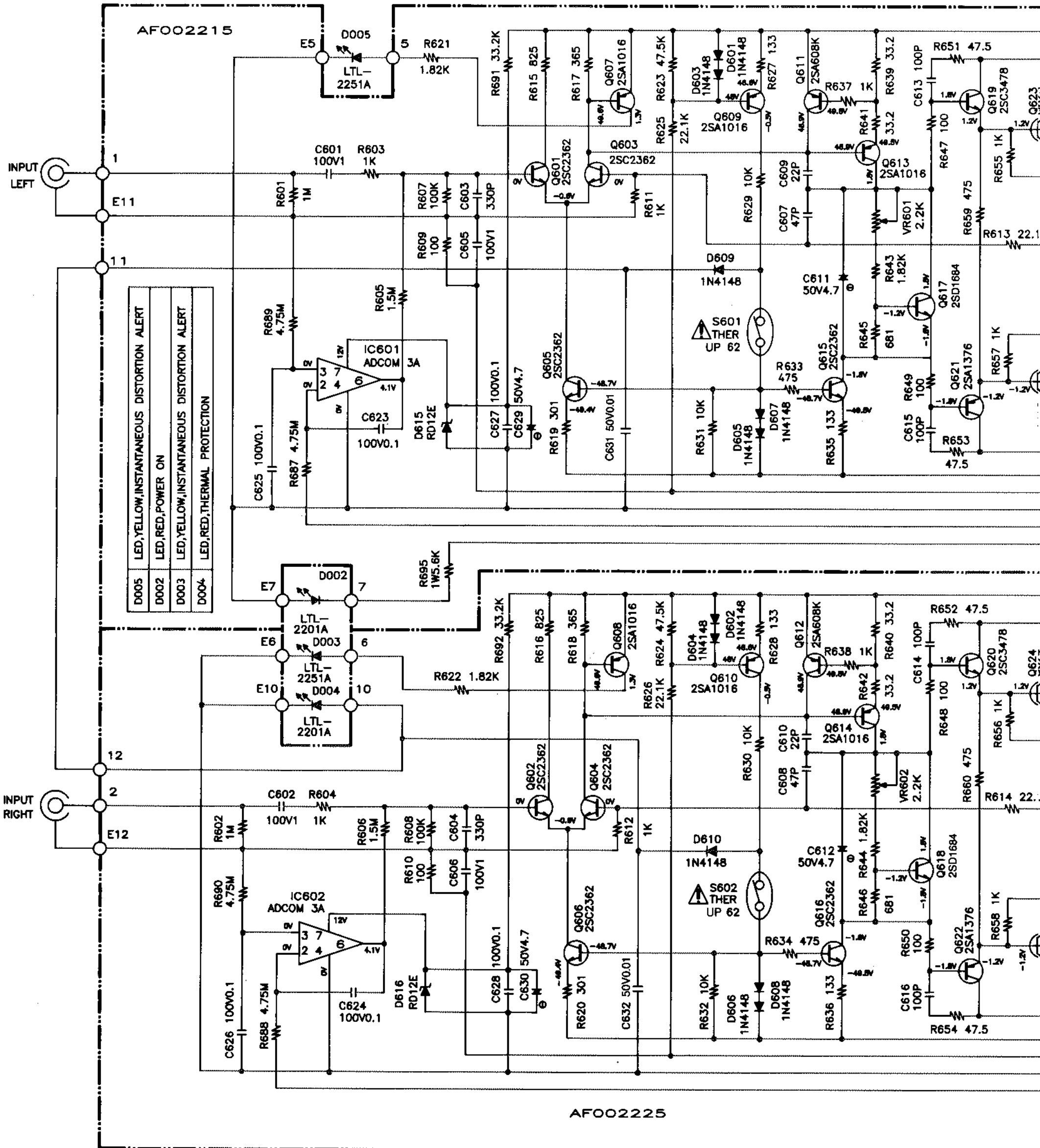

INSTRUCTION TO SERVICE:
 1). USE ONLY REPLACEMENT COMPONENTS WITH IDENTICAL CHARACTERISTICS.
 2). MAKE LEAKAGE-CURRENT TESTS TO DETERMINE THAT COMPONENTS ARE PROPERLY INSULATED FROM THE CHASSIS OF THE UNIT TO THE CU

INSTRUCTION TO MODIFY CIRCUITRY AND/OR CHANGE COMPONENTS
PRIOR NOTICE OR INCURRING ANY LIABILITY.

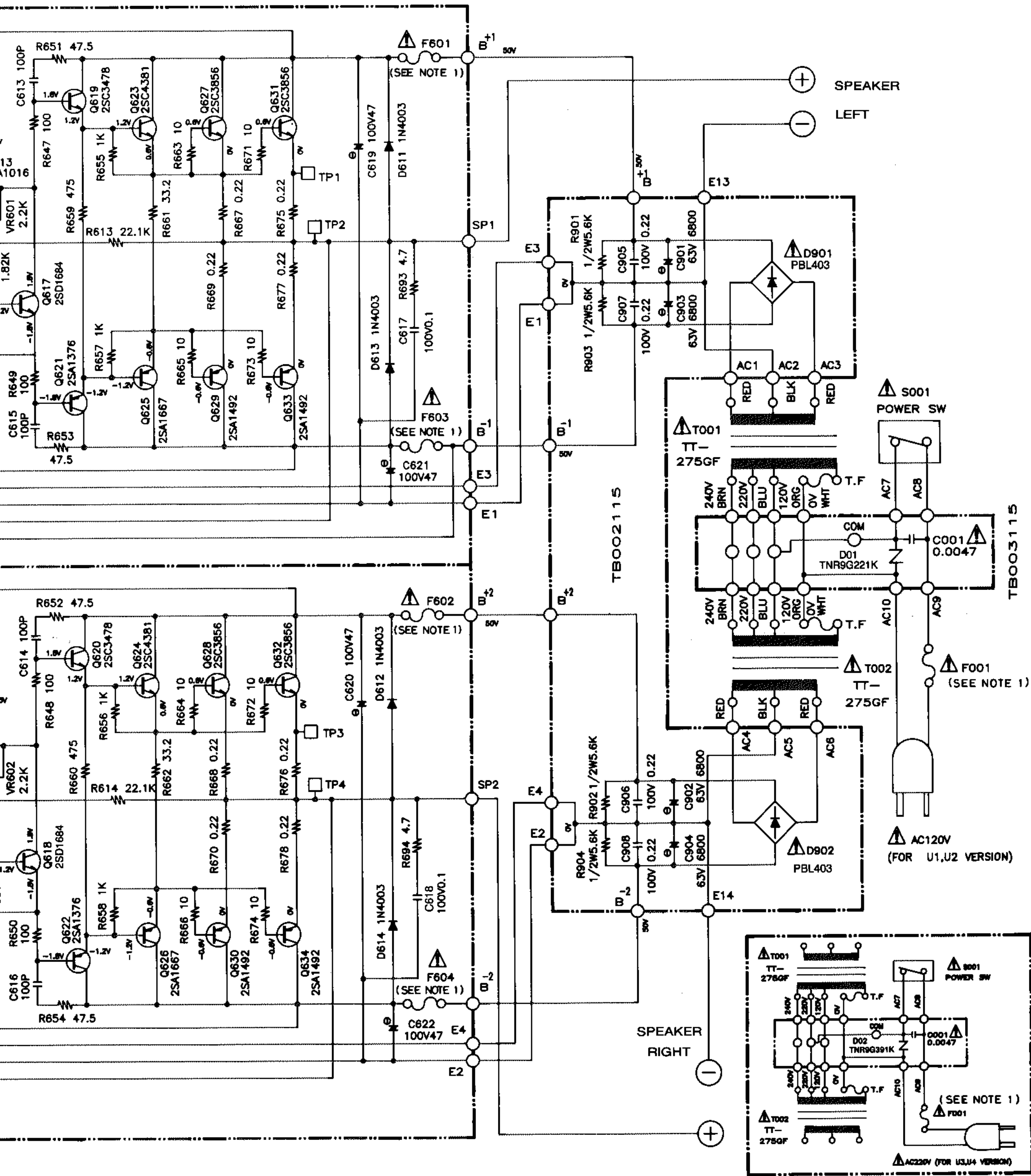

INSTRUCTION TO SERVICING PERSONNEL:
 1). USE ONLY REPLACEMENT PARTS THAT HAVE THE CRITICAL CHARACTERISTICS RECOMMENDED BY MANUFACTURER.
 2). MAKE LEAKAGE-CURRENT OR RESISTANCE MEASUREMENTS TO DETERMINE THAT EXPOSED PARTS ARE ACCEPTABLY INSULATED FROM THE AC SUPPLY CIRCUIT BEFORE RETURNING THE UNIT TO THE CUSTOMER.

FUSES, NOTE 1

BRAND	120V	220V	240V	RAIL
BUSSMAN	AGC-5/250V	AGC-2½/250V	AGC-2½/250V	AGC-4/250V
LITTELFUSE	3AG312005/250V	3AG31202.5/250V	3AG31202.5/250V	3AG312004/250V
BEL	3AG 5A/250V	3AG 2½A/250V	3AG 2½A/250V	3AG 4A/250V